



**UN/CEFACT**

Simple, Transparent and Effective Processes  
For Global Commerce

## **REQUIREMENTS SPECIFICATION MAPPING (RSM)**

**Business Domain: Cross Industry – Supply Chain**

**Business Process: Ordering Process**

**Title: Cross Industry Ordering Process**

**UN/CEFACT International Trade and Business Processes Group: TBG1**

**Version: 2.06.00**

**Release: 1**

## Document Summary

Document Item	Current Value
Document Title	Requirements Specification Mapping Cross Industry Ordering Process
Date Last Modified	26-Jan-2011
Current Document Version	2.06.00
Status	Draft
Document Description (one sentence summary)	Specification that describes the data model and targeted technology solutions for the ordering process.

## Contributors

Name	Organization

## Log of Changes

Issue No.	Date of Change	Changed By	Summary of Change
1.00.01	12-Oct-2009	TBG1	Provided the RSM in the format as required by ICG.
1.00.02	21-Dec-2009	TBG1	Several updates based on ICG second cycle audit pass.
2.00.00	27-Sep-2010	TBG1	Updated to reflect changes in the library.
2.01	29-Oct-10	TBG1	Updated to reflect changes based on TBG17 remarks
2.02	4-Nov-2010	TBG1	Updated to reflect changes based on TBG17 remarks
2.03	4-Dec-10	TBG1	Changed Diagrams, added section 3 for Common RSM
2.04	15-Dec-10	TBG1	Updated Common RSM
2.05	31-Dec-10	TBG1	Fixed composite associations. Updated diagrams 6.2.1. Added notes in section 6.2 on embedded Common Classes and XMI documents. Added XMI diagrams to section 11
2.06	26-Jan-11	TBG1	Added Business Message Template to Section and updated XMI files to section 11

# TABLE OF CONTENTS

<b>1. Preamble</b>	<b>4</b>
<b>2. References</b>	<b>4</b>
<b>3. Objective</b>	<b>4</b>
<b>4. Definition of terms</b>	<b>4</b>
<b>5. Target technology solutions</b>	<b>10</b>
<b>6. Information payload to be implemented</b>	<b>11</b>
6.1. Conceptual Data Model for the Cross Industry Order messages	11
6.2. Canonical Data Model for the Cross Industry Order Messages	11
6.2.1. Cross Industry Order	13
6.2.2. Cross Industry Order Response	14
6.2.3. Cross Industry Order Change	15
6.2.4. CIOH Trade Agreement	16
6.2.5. CIOL Trade Agreement	17
6.2.6. CIOH Trade Delivery	18
6.2.7. CIOL Trade Delivery	19
6.2.8. CIOH Trade Settlement	20
6.2.9. CIOL Supply Chain Trade Settlement	21
6.3. Common Supply Chain Classes	22
<b>7. Business information entity reference</b>	<b>23</b>
7.1. Basic Business Information Entities section	23
7.2. Aggregate Business Information Entities section	24
<b>8. Core components UN/CEFACT Registry version used</b>	<b>43</b>
<b>9. Draft Core Component reference</b>	<b>43</b>
<b>10. Additional documentation</b>	<b>43</b>
<b>11. Additional information</b>	<b>43</b>

## 1. Preamble

The current practice of the exchange of business documents by means of telecommunications – usually defined as e-Business presents a major opportunity to improve the competitiveness of companies, especially for Small and Medium Enterprises (SME).

The ordering process is used to agree on delivery and payment of goods or services between the supplier and the customer.

Started as an initiative by CEN/ISSS Work shop eBES, the European Expert Group 1 (EEG1) – Supply Chain & e-Procurement developed the first draft of Cross Industry Order. The Cross Industry Order has been compiled using the EUROFER ESIDEL version 1.0 as the base, with contributions and submissions from: EUROFER, GS1, CIDX, EDIFICE, AIAG/ODETTE/JAMA, GHX and EDS.

The structure of this document is based on the structure of the UN/CEFACT Requirements Specification Mapping (RSM) – Documentation Template and Conformity Rules, document reference CEFACT/ICG/006.

## 2. References

- UN/CEFACT TBG1 Common Supply Chain BRS, Release 1
- UN/CEFACT TBG1 Cross Industry Order BRS, Release 1

## 3. Objective

In conjunction with the BRS document (CEFACT/ICG/005), the purpose of this document is to provide a standard framework for the exchange of information for

## 4. Definition of terms

Term	Definition
Acceptance Of Goods	1. Date on which the goods are taken over by the carrier at the place of acceptance (CMR 4).
	2. The process of receiving a consignment usually against the issue of a receipt. As and from this moment the party accepting the consignment becomes responsible for the consignment.
Accepted	To take on a responsibility or liability for something.
Account	A formal contractual relationship established to provide for regular banking, brokerage or business services.
Accounting	Record or statement of financial transactions.
Agent	A person or company that provides a particular service, typically one organizing transactions between two other parties.
Allowance	The amount of something allowed.
Allowance Charge	Details about a component of pricing, such as a service, promotion, allowance or charge.

Term	Definition
Amount	A number of monetary units specified in a currency where the unit of currency is explicit or implied.
Available	1. Able to be used or obtained. 2. Goods positioning date/time, expected – Date/time on which goods are expected to be positioned.
Batch	n. A quantity or consignment of goods produced at one time. v. Arrange (things) in sets or groups.
Batch (No.)	(Identification of) a quantity or consignment of goods produced at one time.
Buyer	The party to which goods or services are sold.
Carrier	The party undertaking the transportation of goods from one point to another.
Cash	Money in the form of bills and coins.
Catalogue	A list of items arranged in a systematic order.
Category	A class or division of people or things having particular shared characteristics.
Characteristic	A feature or quality typical of a person, place, or thing.
Charge	An amount asked as a price for a service rendered or goods supplied (OED derived).
Classification	Arrangement (of a group) in classes or categories according to shared qualities or characteristics.
Commission	A sum paid to an agent in a commercial transaction.
Communication	The means of sending or receiving information, such as telephone lines or computers.
Communication (Address)	The unique identification of location, person or company within a specific means of sending or receiving information, such as telephone lines or computers.
Condition	The state of something or someone, with regard to appearance, fitness, or working order.
Conditions	1 Circumstances affecting the functioning or existence of something. 2 A state of affairs that must exist before something else is possible.
Consignee	The party by whom the goods, cargo or containers are meant to be received. The actual physical receipt can take place by another party.
Consignment	A separately identifiable collection of goods items (available to be) transported from one consignor to one consignee via one or more modes of transport as specified in one single transport document.
Consignor	The party by whom goods, cargo and containers are sent. The physical dispatch can be done by another party.
Context	The circumstances that form the setting for an event, statement, or idea, and in terms of which it can be fully understood.
Contract	A legally binding agreement between two parties in which the specific titles, rights, commitments and obligations of both parties are defined.

Term	Definition
Count	The total determined by counting.
Country Of Arrival	The country to which a means of transport is scheduled to arrive or has arrived.
Country Of Departure	The country from which a means of transport is scheduled to depart or has departed.
Country Of Destination	The country to which goods are (to be) transported.
Country Of Origin	The country in which the goods have been produced or manufactured, according to criteria laid down for the purposes of application of the Customs tariff, of quantities restrictions, or of any other measure related to trade.
Country Sub-division	A formally recognized subdivision of a country.
Creditor	One who gives credit for money or goods; one to whom a debt is owing; correlative to debtor.
Currency	That which is current as a medium of exchange; the circulating medium (whether coins or notes); the money of a country in actual use.
Currency Exchange	The conversion of financial amounts in one currency to another.
Customer	The party to which or to whom goods and/or services are supplied.
Customs	The government organization that deals with the levying of duties and taxes on imported goods from foreign countries and the control over the export and import of goods.
Date	Identification of a particular calendar day, expressed by some combination of the data elements calendar year, calendar month, calendar week, calendar day, of day of the year.
Deductible	An amount or percentage that can be taken away from or applied to another amount for purpose of reduction.
Deduction	An amount that is or may be deducted.
Deliver	Bring and handover (a letter, goods or service) to the appropriate recipient.
Delivered	The quantity provided (of something promised or expected).
Delivery	1. The action of delivering something, especially letters, goods or services. 2. The physical process of handing over goods to the consignee or to the party acting on his behalf.
Delivery Date	The date on which the delivery of goods to takes place, is scheduled to take place, or must be received.
Delivery Terms	Conditions in a sales or transportation contract that specify the carrier, routing, freight charges, place of delivery, time of delivery, etc.
Dimension	A measurable extent, such as length, breadth or height.
Disbursement	The action of dispersing money that is paid out.
Discharge	The process of unloading the goods from a means of transport.
Discount	1. A deduction from the usual cost of something.

Term	Definition
	2. (Finance) a percentage deducted from the face value of a bill of exchange or promissory note when it changes hands before the due date.
Due	Required as a legal or moral obligation.
	Expected at, planned for, or required by a certain time.
Duration	The time during which something continues.
Duty	A payment levied on the import, export, manufacture, or sale of goods or services.
Earliest	Not before the time or date specified.
Effective Period	The time during which something runs its course, duration; allotted time; natural lifespan.
Electronic Communication	Communications in the general sense of any communication that involves having components such as microchips and transistors that control and direct electric currents. Used to encompass, fax, telephone, e-mail, EDI, etc.
End	To come or bring to an end; finish..
Event	A significant occurrence or happening related to an object process, or person.
Exclusive	Not divided or shared with others.
Expected	Regarded as likely to happen..
Expiry	The end or term of a period of time.
Family Name	A surname, the hereditary name common to all members of a family, as distinct from a forename.
Fee	A payment made to a professional person or to a professional or public body in exchange for advice or services.
Fiscal	Of or relating to government revenue, especially taxes.
Freight	Goods in transport from one location to another.
Freight Costs	Costs incurred when moving goods, by whatever means, from one place to another under the terms of a contract of carriage. In addition to transport costs, this may include such elements as packing, documentation, loading , unloading, and insurance (to the
	2. The amount of money due for the carriage of goods and payable either in advance or upon delivery.
Frequency	1) The rate at which something occurs over a period or in a given sample.
	2) Occurrence many times at short intervals.
Given Name	Another term for first name, a personal name given to someone at birth or baptism and used before (or after in some national styles) a family name.
Gross	Without deduction of tax or other contributions.
	Including contents or other variable items; overall.
Gross Price	Price inclusive of all discounts, rebates, etc.; sometimes called the retail price.
IBAN	Abbreviation of International Bank Account Number.

Term	Definition
Identification	The action or process of identifying or the fact of being identified.
Identifier	Something which identifies.
Invoice	
Invoicee	One who receives the invoice and is expected to arrange its settlement.
Invoicer	One who issues the invoice.
Issued	1) supplied or distributed for use. 2) formally sent out or made known.
Level (Packaging)	The position in a series of packaging that groups items together within a package within a package etc..
Line Item	An article or unit of any kind included in an enumeration, computation, or sum total.
Location	A particular place or position.
Logistic Service Provider	Party providing logistic services such as warehousing, re-packing products, distribution and assembly.
Lot (No.)	(Identification of) a particular group or set of people or things.
Maximum	The highest value or extreme limit.
Means (Of Payment Guarantee)	This indicates the kind of guarantee covering the payment.
Means (Of Payment)	The method used for payment.
Means (Of Settlement)	An act that discharges obligations in respect of funds or securities transfers between two or more parties.
Means (Of Transport)	The particular vehicle used for the transport of goods or persons.
Measure	A standard unit used to express size, amount, or degree.
Measurement	An amount, size, or extent as established by measuring.
Minimum	The smallest amount or quantity that is possible, usual, attainable, allowable, etc.
Monetary Adjustment	See Allowance Charge
Net	(Of an amount, value or price) remaining after deduction of tax or other contributions.
Net Price	Price after all discounts, rebates, etc., have been allowed; sometimes called the wholesale price.
Net Volume	1. The amount or quantity of something free from, or not subject to, any (further) deduction. 2. (Of a weight) excluding that of packaging.
Net Weight	Measurement of quantity by means of weighing, free from, or not subject to, any (further) deduction.
Non Repudiation	Non repudiation means that the originator must digitally sign the business data and the recipient must store the business data in its original form for the mutually agreed duration.
Number	An arithmetic value, expressed by a word, symbol or figure, representing a particular amount.
Original	1. The earliest form of something.



Term	Definition
	2. Existing from the beginning: first or earliest.
Package	1. The final product of the packing operation.
	2. Consisting of the packing and the contents, e.g. a box, carton, crate, barrel, pallet, etc.
Packaging	The action or process of making something into a package or enclosing a thing in packaging; the action of wrapping something up.
Payee	A person or company to whom money is being paid or is due, especially in a transaction such as the payment of a cheque or money order.
Payment	The action of paying or the process of being paid.
Payment Terms	Conditions or stipulations limiting the paying of money or its equivalent for (also of) goods, services, etc.
Payor	The person or company named as responsible for the payment of a cheque, money order, or other financial 'paper' when it is redeemed.
Percentage	1) A rate, number, or amount in each hundred. 2) Any proportion or share in relation to a whole.
Period (Of Time)	A length or portion of time.
	A portion of time between two time points.
Prepaid	Paid for in advance.
Pre-Payment	Payment that has taken place before the delivery.
Previous	Existing or occurring before in time or order.
Price	The amount of money (or a material equivalent) expected, required, or given in payment for a commodity or service.
Product	Any tangible output or service produced by human or mechanical effort or by a natural process.
Product Instance	An instance of an individual product or batch of similar products produced by human or mechanical effort or by a natural process.
Quantity	A certain amount or number.
Rate	Numeric information that is assigned or is determined by calculation, counting, or sequencing. It does not require a unit of quantity or unit of measure.
Rate Basis	The basis of calculation of an amount of a charge or payment expressed as an amount per some feature.
Received	Taken delivery of.
Regime	A systematic or ordered way of doing something.
Regulation	A rule prescribed for the management of some matter, or for the regulating of conduct; a governing precept or direction; a standing rule.
Remittance	A sum of money remitted.
Seller	The party selling goods or services.
Sequence	The fact of following after or succeeding; the following of one thing after another in succession; an instance of this.

Term	Definition
Serial Number	An identification number showing the position of a manufactured item in a series.
Service	Work or doing of work for another or for a community such as utilities and transport.
Service Charge	A charge made for banking or other services such as Freight Services.
Settlement	'settle' – pay (a debt or account)
Status	The position of affairs at a particular time.
Subdivision	Subdivisions of a country such as primary subdivisions, County (UK), Departement (France), State (US) etc., secondary subdivisions such.
Supplier	Someone who makes (something needed) available to someone.
Tariff	A classified list or scale of charges made in any private or public business; as, a hotel tariff, a railroad tariff.
	A tax or duty to be paid on a particular class of imports or exports.
Tax	A levy or payment for the support of a government required of persons, groups, or businesses within the domain of that government.
Terms Of Delivery	All the conditions agreed upon between a seller and a buyer with regard to the delivery of goods and/or services, e.g. CIF, FOB, or EXW from the INCOTERMS Terms of Delivery.
Terms Of Freight	All the conditions (to be) agreed upon between a transport service provider and a transport service buyer about the type of freight and charges due to carriage and whether they are prepaid or are to be collected.
Terms Of Transport	All the conditions agreed upon between a transport service provider and a transport service buyer with regard to the transportation of goods, e.g. CIF, FOB, or EXW from the INCOTERMS Terms of Delivery.
Type	A category of people or things having common characteristics.
Ultimate Consignee	A final person to whom goods are consigned.
Value	1. Material or monetary worth.
	2. The numerical amount denoted by an algebraic term; a magnitude, quantity, or number.

## 5. Target technology solutions

The CII v2 solution requires a UN/CEFACT XML standard schema.

The CII v2 solution will not be implemented as a UN/EDIFACT standard message.

## 6. Information payload to be implemented

### 6.1. Conceptual Data Model for the Cross Industry Order messages

#### Philosophy behind the conceptual design

The conceptual design is based on the assumption that information exchanged in the order-to-pay process tends to have a large degree of similarity. Therefore rather than linking the information to message specific entities three neutral entities have been defined: Trade Agreement, Trade Delivery and Trade Settlement. These entities contain the main semantic payload for all communication exchanges, on header as well as on line level.

A fourth essential entity is the Product entity. This entity holds all characteristics of the trade product that are independent of a particular trade transaction.

The Trade Transaction and Trade Line Item entities serve to structure the entities mentioned before.

#### Description of the main entities

- Document Context: Application processing information for the business document.
- Document Heading: Generic document heading information such as Order number, Issue date.
- Trade Transaction: Information on the trade transaction(s) to which the order applies.
- Trade Line Item: Information on the line items that are being ordered.
- Trade Agreement: information on the commercial agreement on which the ordered trade transaction or line is based.
- Trade Delivery: information on the fulfillment of the order trade transaction or line.
- Trade Settlement: information on the financial settlement of the order trade transaction or line.
- Product: Information on the generic object that is being ordered.
- Product Instance: Information on the individual objects that are being ordered.

### 6.2. Canonical Data Model for the Cross Industry Order Messages

For readability reasons the canonical model is provided in multiple diagrams, each providing a full description of a segment in the Cross Industry Order messages.



**Note:** The three entities Trade Agreement, Trade Delivery and Trade Settlement have been depicted as identical on header and line level, since these entities are meant to support the entire Order-to-Pay process. In the individual steps of the process, such as the order, further refinements can be made on what is communicated on header and line level. Therefore in the canonical model for the Order message the three conceptual entities are realized as six message specific entities, one for the header and one for the line.

**Note:** The Common Supply Chain Classes – section 6.3 promotes interoperability across Supply Chain Messages. It also provides easier maintenance / reduces errors and therefore

diagrams in section 6.2 only point to the entities in the common classes. The detail of how the entities relate to each other is contained only in the embedded document in section 6.3. and therefore you should refer to this document for all relationships between common entities.

**Note:** XMI documents that comply with the XMI standard version 2.1 are embedded in section 11. These documents will allow you to upload the diagrams into many diagramming / code generation applications.



### 6.2.2. Cross Industry Order Response

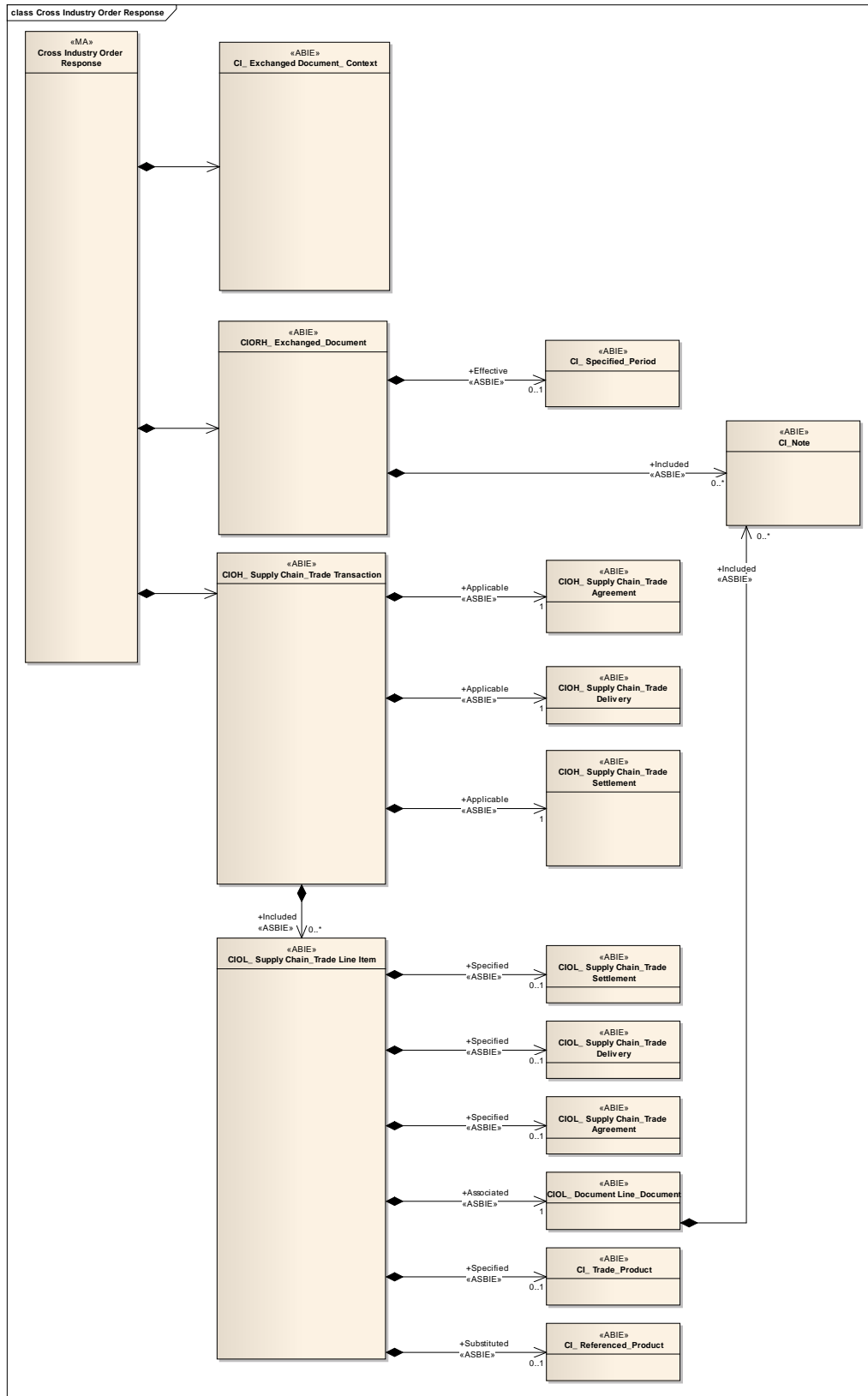

### 6.2.3. Cross Industry Order Change

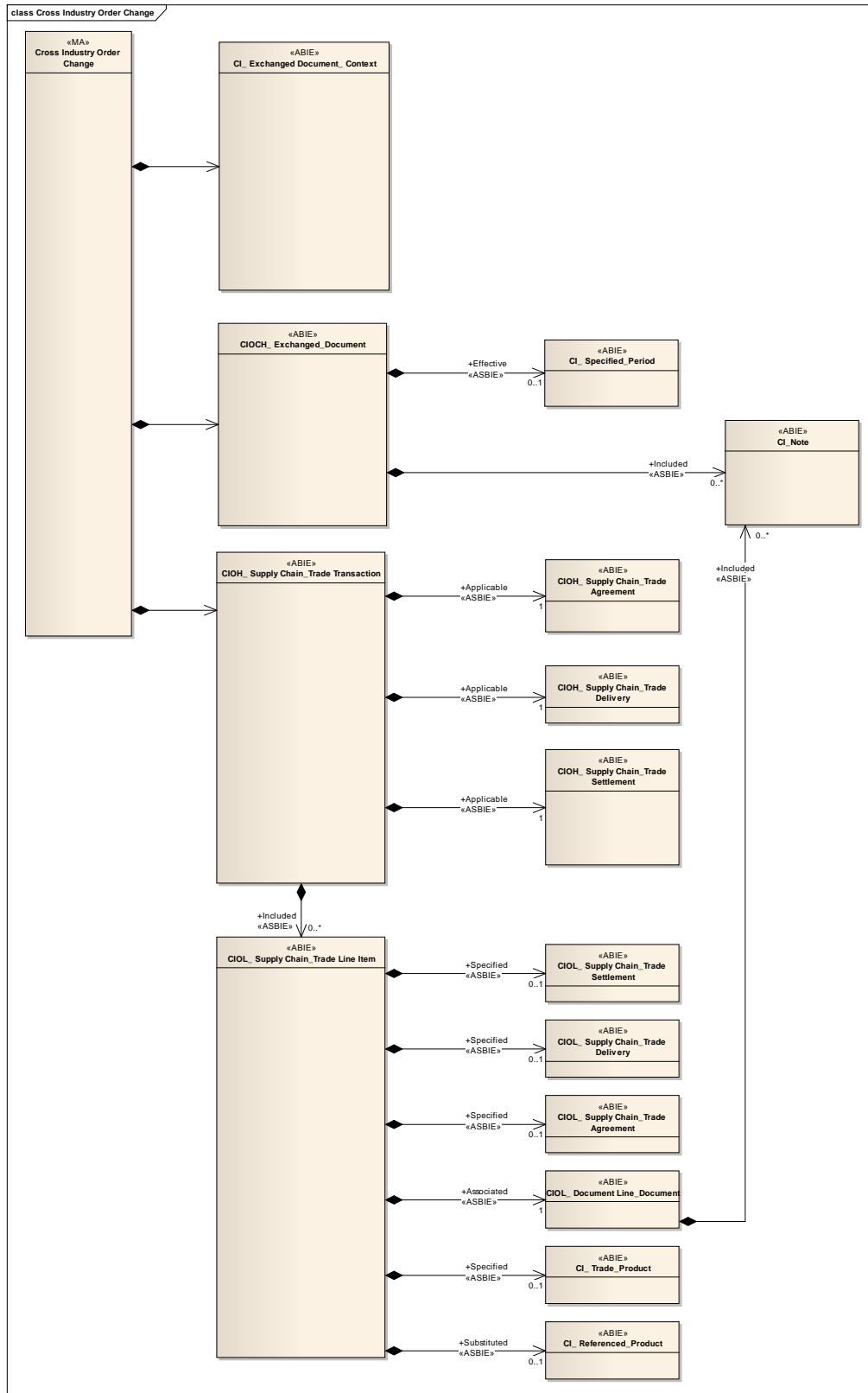

## 6.2.4. CIOH Trade Agreement

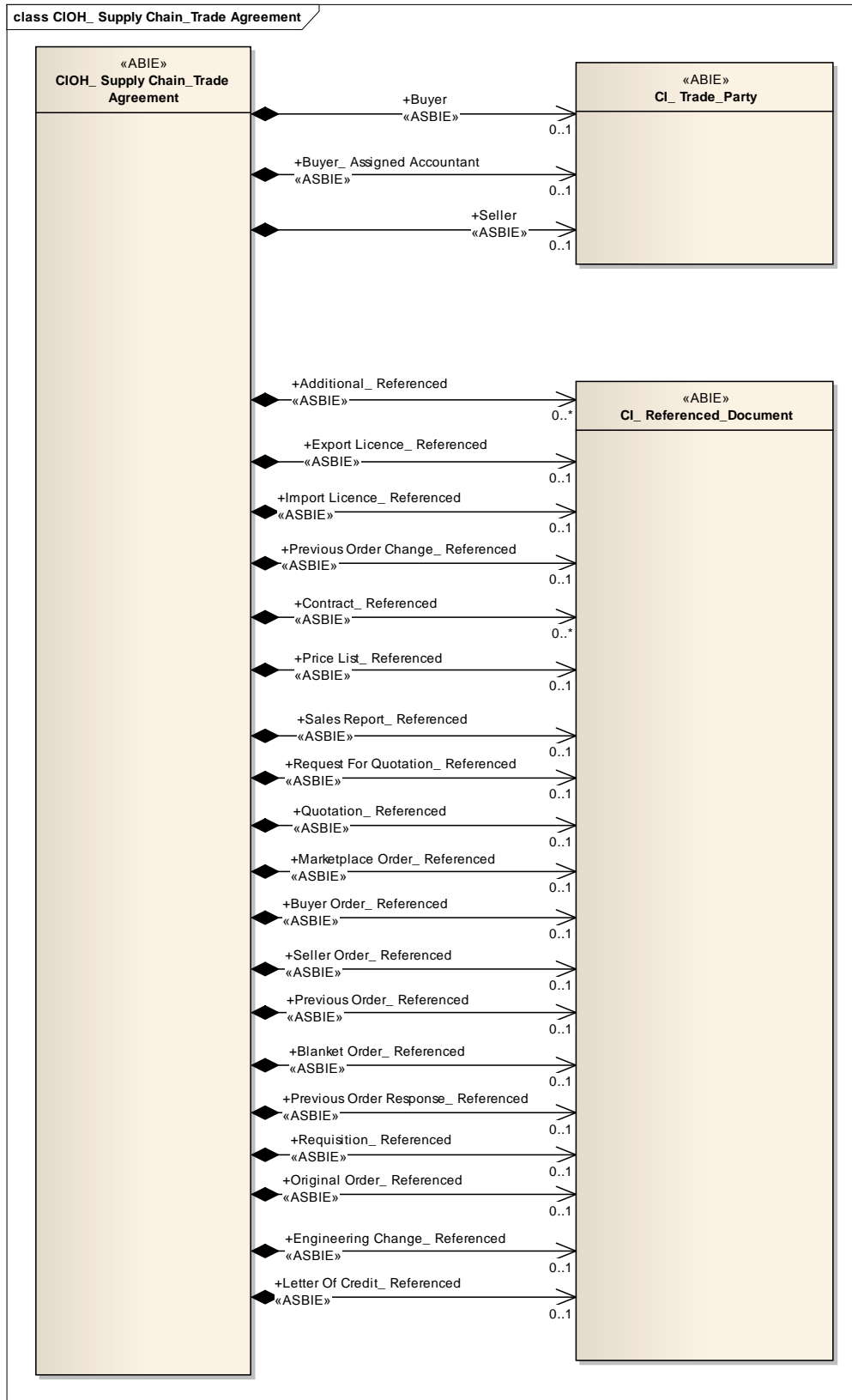



### 6.2.5. CIOL Trade Agreement

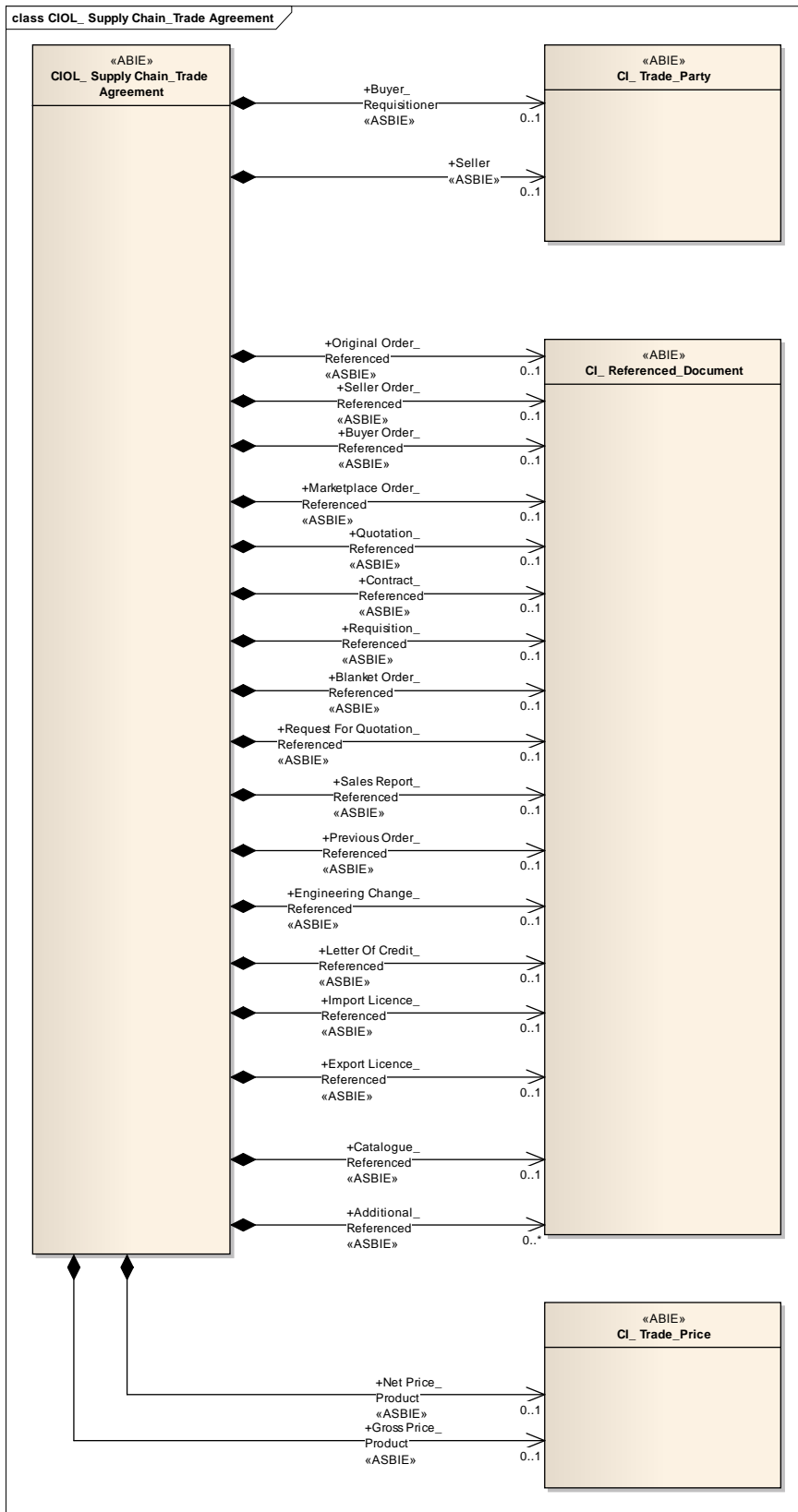

## 6.2.6. CIOH Trade Delivery

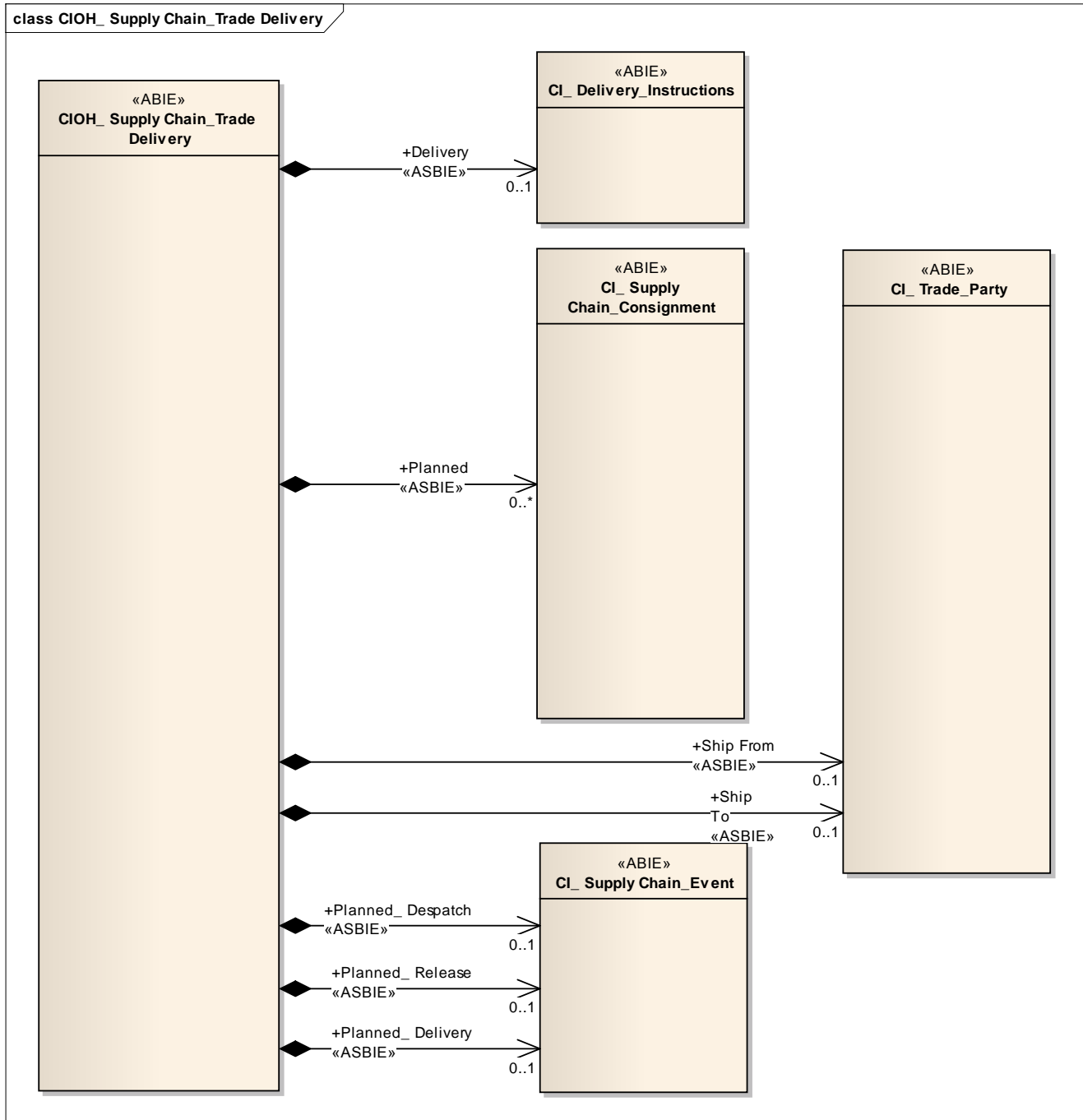

## 6.2.7. CIOL Trade Delivery

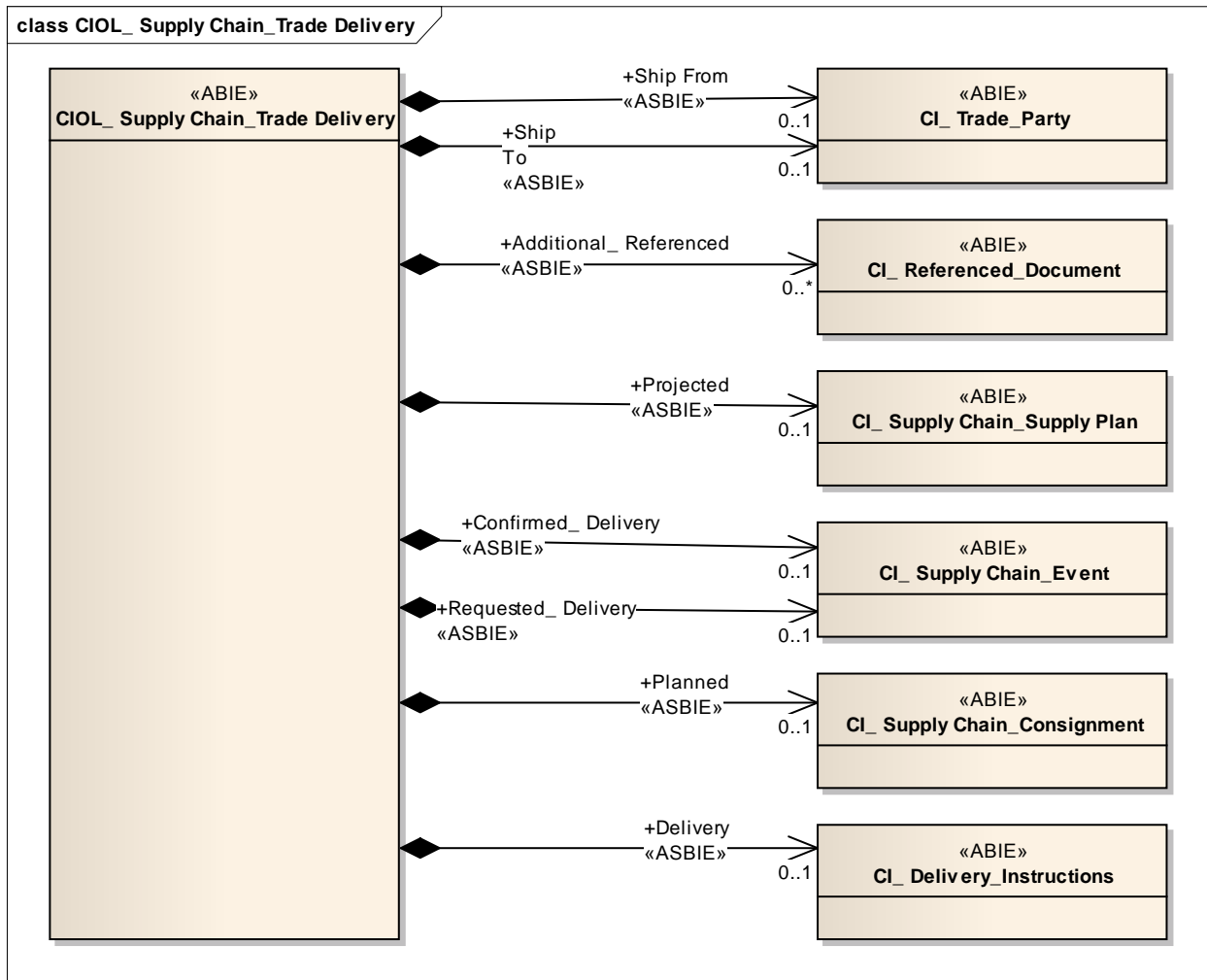

### 6.2.8. CIOH Trade Settlement

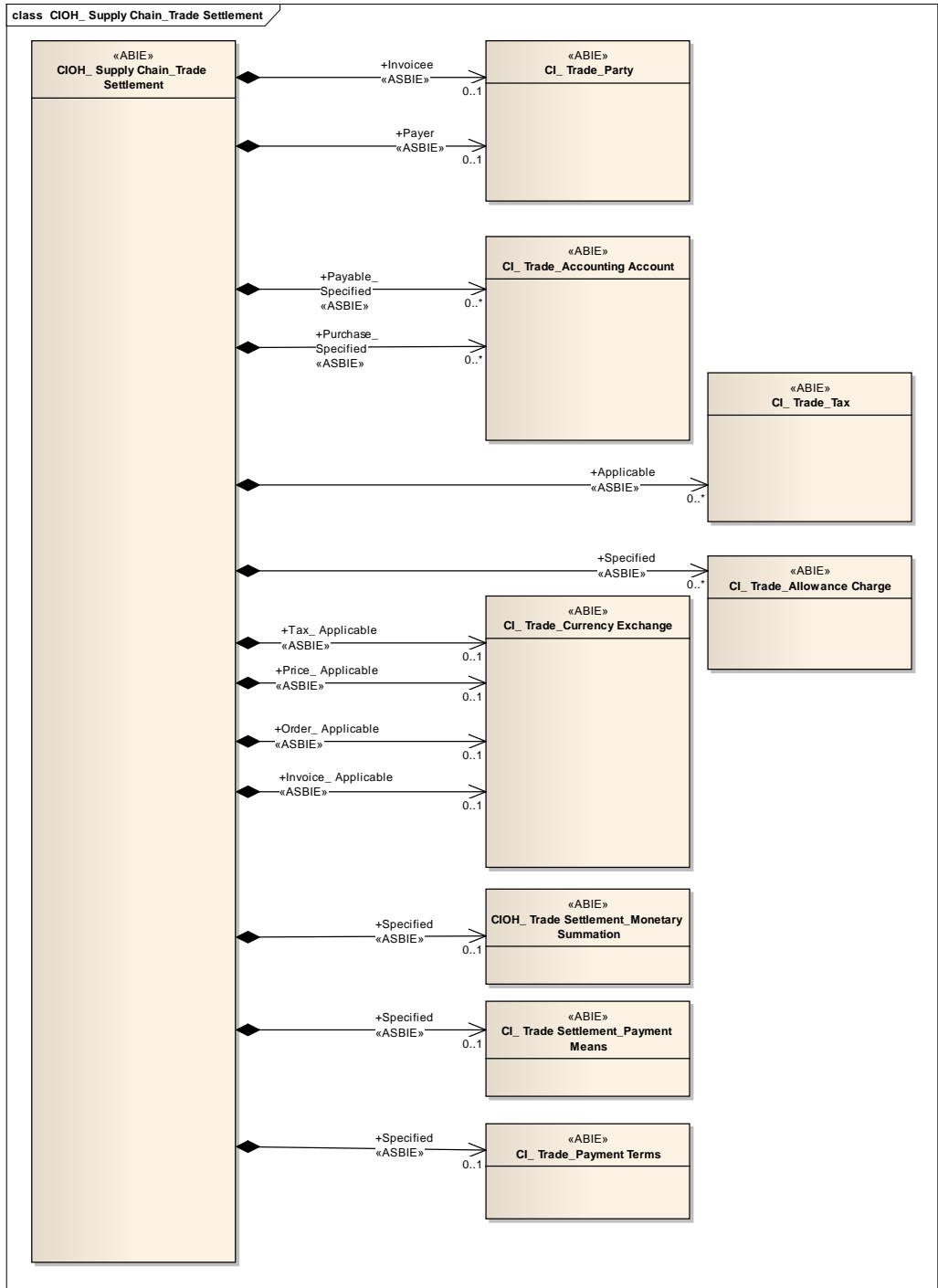

## 6.2.9. CIOL Supply Chain Trade Settlement

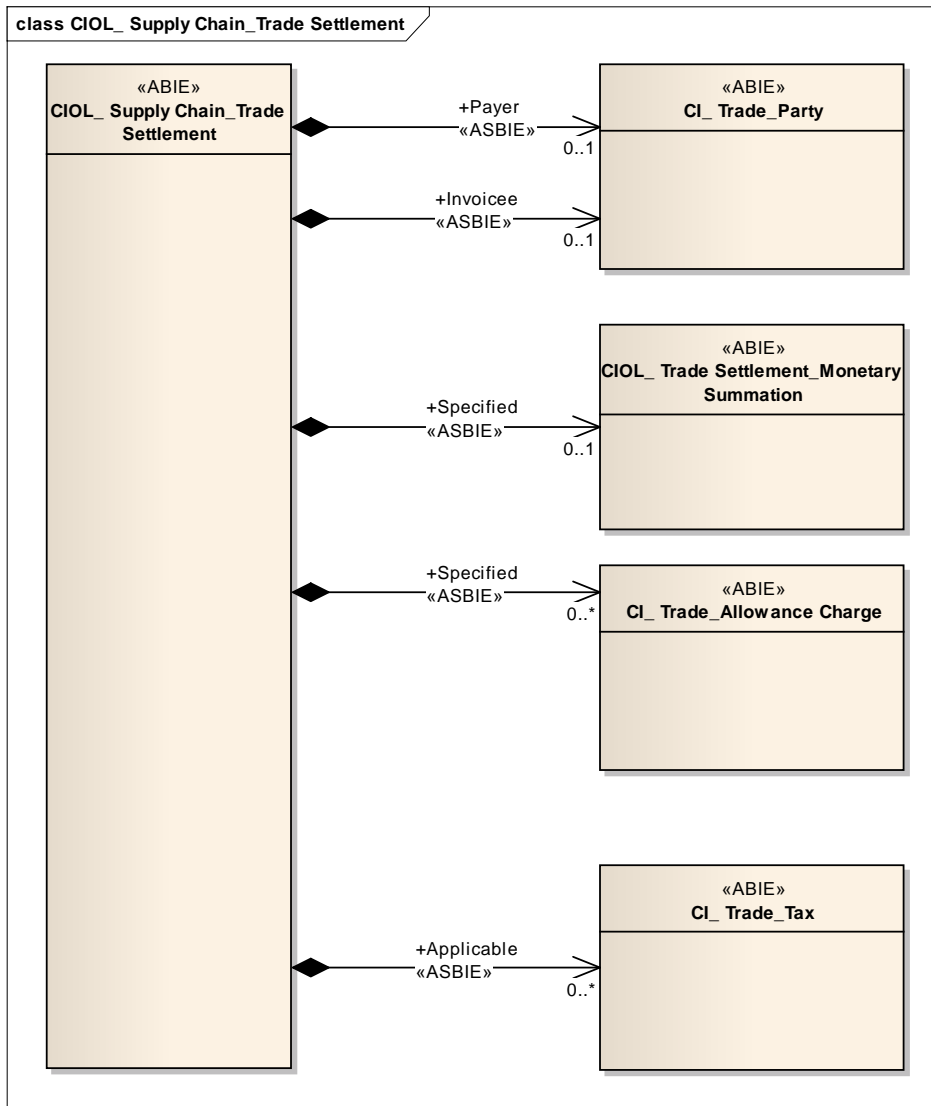

## 6.2.10. CIOL\_Document Line\_Document

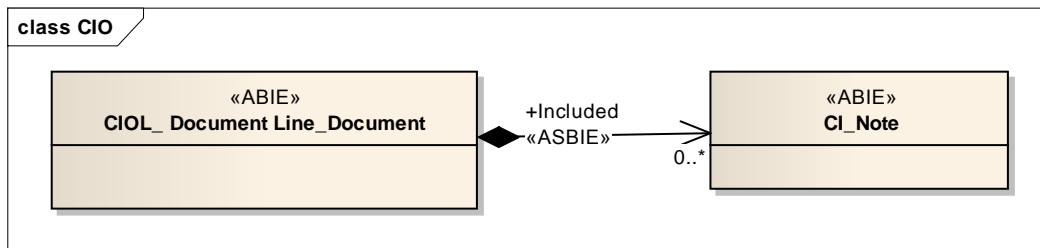

### 6.3. Common Supply Chain Classes

The following embedded Document contains the details and UML diagrams of the reusable common information elements classes covering the requirements for the cross industry supply chain processes as described in the Common Supply Chain BRS v 1.00.05 - for reuse in TBG1 RSMs



Specification TBG1  
RSM Common Supply

## 7. Business information entity reference

This section contains the list of all the Business Information Entities that are both used within the canonical data model and are variations from the standard Core Components, including the UN/CEFACT Registry version that served as the reference point.

### 7.1. Basic Business Information Entities section

This section identifies any restrictions that have to be applied to the BBIE in the context in which it is being used.

BBIE Dictionary Entry Name	Qualified Data Type	Core Component DEN	CC Restriction Type	CC Restriction	SC Restriction Type	SC Restrictions	UNCL TDED
CIOH_ Exchanged_ Document. Type. Code	Document	Document. Type. Code	Enumeration	UNCL 1001 list	None	None	1001
CIOCH_ Exchanged_ Document. Purpose. Code	Message Function.	Document. Purpose. Code	Enumeration	UNCL 1225 list	None	None	1225
CIOCH_ Exchanged_ Document. Type. Code	Document	Document. Type. Code	Enumeration	UNCL 1001 list	None	None	1001
CIORH_ Exchanged_ Document. Type. Code	Document	Document. Type. Code	Enumeration	UNCL 1001 list	None	None	1001
CIOL_ Document Line_ Document. Line Status. Code	Line Status	Document. Line Status. Code	Enumeration	UNCL 1229 List	None	None	1229
CIOH_ Supply Chain_ Trade Settlement. Tax_ Currency. Code	Currency	Trade Settlement. Currency. Code	Enumeration	UNCL 6345 List	None	None	6345

BBIE Dictionary Entry Name	Qualified Data Type	Core Component DEN	CC Restriction Type	CC Restriction	SC Restriction Type	SC Restrictions	UNCL TDED
CIOH_Supply Chain_Trade Settlement_Order_Currency.Code	Currency	Trade Settlement.Currency.Code	Enumeration	UNCL 6345 List	None	None	6345
CIOH_Supply Chain_Trade Settlement_Invoice_Currency.Code	Currency	Trade Settlement.Currency.Code	Enumeration	UNCL 6345 List	None	None	6345
CIOH_Supply Chain_Trade Settlement_Price_Currency.Code	Currency	Trade Settlement.Currency.Code	Enumeration	UNCL 6345 List	None	None	6345
CIOL_Document Line_Document.Line Status.Code	Line Status	Document.Line Status.Code	Enumeration	UNCL 1229 List	None	None	1229
CIORH_Exchanged_Document.Type.Code	Document	Document.Type.Code	Enumeration	UNCL 1001 list	None	None	1001
CIORH_Exchanged_Document.Purpose.Code	Message Function	Document.Purpose.Code	Enumeration	UNCL 1225 list	None	None	1225

## 7.2. Aggregate Business Information Entities section



Occurrence	Element/Attribute
	<b>ABIE</b> <b>CIOH_ Exchanged_ Document. Details</b>
1 .. 1	—BBIE Definition: CIOH_ Exchanged_ Document. Identification. Identifier The identifier of this CIOH exchanged document.
0 .. unbounded	—BBIE Definition: CIOH_ Exchanged_ Document. Name. Text A name, expressed as text, of this CIOH exchanged document.
0 .. 1	—BBIE Definition: CIOH_ Exchanged_ Document. Type. Code The code specifying the type of CIOH exchanged document.
1 .. 1	—BBIE Definition: CIOH_ Exchanged_ Document. Issue. Date Time The date, time, date time, or other date time value for the issuance of this CIOH exchanged document.
0 .. 1	—BBIE Definition: CIOH_ Exchanged_ Document. Copy. Indicator The indication of whether or not this CIOH exchanged document is a copy.
0 .. unbounded	—BBIE Definition: CIOH_ Exchanged_ Document. Language. Identifier A language identifier for this CIOH exchanged document.
0 .. 1	—BBIE Definition: CIOH_ Exchanged_ Document. Purpose. Code The code specifying the purpose of this CIOH exchanged document, such as request or reminder.
0 .. 1	—BBIE Definition: CIOH_ Exchanged_ Document. Revision. Date Time The date, time, date time, or other date time value for the revision of this CIOH exchanged document.
0 .. 1	—BBIE Definition: CIOH_ Exchanged_ Document. Version_ Identification. Identifier The version identifier for this CIOH exchanged document.
0 .. 1	—BBIE Definition: CIOH_ Exchanged_ Document. Global_ Identification. Identifier The global identifier for this CIOH exchanged document.
0 .. 1	—BBIE Definition: CIOH_ Exchanged_ Document. Revision_ Identification. Identifier The revision identifier of this CIOH exchanged document.
0 .. 1	—BBIE Definition: CIOH_ Exchanged_ Document. Previous Revision_ Identification. Identifier The identifier of the previous revision of this CIOH exchanged document.
0 .. 1	—BBIE Definition: CIOH_ Exchanged_ Document. Category. Code The code specifying the category for this CIOH exchanged document.
0 .. 1	—BBIE Definition: CIOH_ Exchanged_ Document. Response Reason. Code The code specifying the response reason for this CIOH exchanged document.
0 .. unbounded	—ASBIE Definition: <b>CIOH_ Exchanged_ Document. Included. CI_ Note</b> A note included in this CIOH exchanged document.
0 .. 1	—ASBIE Definition: <b>CIOH_ Exchanged_ Document. Effective. CI_ Specified_ Period</b> The specified period for which this CIOH exchanged document is effective.

Occurrence	Element/Attribute
	<b>ABIE</b> <b>CIOCH_ Exchanged_ Document. Details</b>
1 .. 1	—BBIE Definition: CIOCH_ Exchanged_ Document. Identification. Identifier The identifier of this CIOCH exchanged document.
0 .. unbounded	—BBIE Definition: CIOCH_ Exchanged_ Document. Name. Text A name, expressed as text, of this CIOCH exchanged document.
0 .. 1	—BBIE Definition: CIOCH_ Exchanged_ Document. Type. Code The code specifying the type of CIOCH exchanged document.
1 .. 1	—BBIE Definition: CIOCH_ Exchanged_ Document. Issue. Date Time The date, time, date time, or other date time value for the issuance of this CIOCH exchanged document.
0 .. 1	—BBIE Definition: CIOCH_ Exchanged_ Document. Copy. Indicator The indication of whether or not this CIOCH exchanged document is a copy.
0 .. unbounded	—BBIE Definition: CIOCH_ Exchanged_ Document. Language. Identifier A language identifier for this CIOCH exchanged document.
0 .. 1	—BBIE Definition: CIOCH_ Exchanged_ Document. Purpose. Code The code specifying the purpose of this CIOCH exchanged document.
0 .. 1	—BBIE Definition: CIOCH_ Exchanged_ Document. Revision. Date Time The date, time, date time or other date time value for the revision of this CIOCH exchanged document.
0 .. 1	—BBIE Definition: CIOCH_ Exchanged_ Document. Version_ Identification. Identifier The version identifier for this CIOCH exchanged document.
0 .. 1	—BBIE Definition: CIOCH_ Exchanged_ Document. Global_ Identification. Identifier The global identifier for this CIOCH exchanged document.
0 .. 1	—BBIE Definition: CIOCH_ Exchanged_ Document. Revision_ Identification. Identifier The revision identifier for this CIOCH exchanged document.
0 .. 1	—BBIE Definition: CIOCH_ Exchanged_ Document. Previous Revision_ Identification. Identifier The identifier of the previous revision of this CIOCH exchanged document.
0 .. 1	—BBIE Definition: CIOCH_ Exchanged_ Document. Category. Code The code specifying the category for this CIOCH exchanged document.
0 .. 1	—BBIE Definition: CIOCH_ Exchanged_ Document. Response Reason. Code The code specifying the response reason for this CIOCH exchanged document.
0 .. unbounded	—ASBIE <b>Definition: CIOCH_ Exchanged_ Document. Included. CI_ Note</b> A note included in this CIOCH exchanged document.
0 .. 1	—ASBIE <b>Definition: CIOCH_ Exchanged_ Document. Effective. CI_ Specified_ Period</b> The specified period within which this CIOCH exchanged document is effective.

Occurrence	Element/Attribute
	<b>ABIE</b> <b>CIORH_ Exchanged_ Document. Details</b>
1 .. 1	—BBIE Definition: CIORH_ Exchanged_ Document. Identification. Identifier The unique identifier of this CIORH exchanged document.
0 .. unbounded	—BBIE Definition: CIORH_ Exchanged_ Document. Name. Text A name, expressed as text, of this CIORH exchanged document.
0 .. 1	—BBIE Definition: CIORH_ Exchanged_ Document. Type. Code The code specifying the type of CIORH exchanged document.
1 .. 1	—BBIE Definition: CIORH_ Exchanged_ Document. Issue. Date Time The date, time, date time, or other date time value for the issuance of this CIORH exchanged document.
0 .. 1	—BBIE Definition: CIORH_ Exchanged_ Document. Copy. Indicator The indication of whether or not this CIORH exchanged document is a copy.
0 .. 1	—BBIE Definition: CIORH_ Exchanged_ Document. Purpose. Text The purpose, expressed as text, of this CIORH exchanged document.
0 .. unbounded	—BBIE Definition: CIORH_ Exchanged_ Document. Language. Identifier A language identifier for this CIORH exchanged document.
0 .. 1	—BBIE Definition: CIORH_ Exchanged_ Document. Purpose. Code The code specifying the purpose of this CIORH exchanged document, such as request or reminder.
0 .. 1	—BBIE Definition: CIORH_ Exchanged_ Document. Revision. Date Time The date, time, date time, or other date time value for the revision of this CIORH exchanged document.
0 .. 1	—BBIE Definition: CIORH_ Exchanged_ Document. Version_ Identification. Identifier The identifier for the version of this CIORH exchanged document.
0 .. 1	—BBIE Definition: CIORH_ Exchanged_ Document. Global_ Identification. Identifier The global identifier for this CIORH exchanged document.
0 .. 1	—BBIE Definition: CIORH_ Exchanged_ Document. Revision_ Identification. Identifier The revision identifier of this CIORH exchanged document.
0 .. 1	—BBIE Definition: CIORH_ Exchanged_ Document. Previous Revision_ Identification. Identifier The identifier of the previous revision of this CIORH exchanged document.
0 .. 1	—BBIE Definition: CIORH_ Exchanged_ Document. Category. Code The code specifying the category for this CIORH exchanged document.
0 .. 1	—BBIE Definition: CIORH_ Exchanged_ Document. Response Reason. Code The code specifying the response reason for this CIORH exchanged document.
0 .. unbounded	—ASBIE <b>CIORH_ Exchanged_ Document. Included. CI_ Note</b> Definition: A note included in this CIORH exchanged document.
0 .. 1	—ASBIE <b>CIORH_ Exchanged_ Document. Effective. CI_ Specified_ Period</b> Definition: The specified period within which this CIORH exchanged document is effective.

Occurrence	Element/Attribute
	<b>ABIE CIOH_ Supply Chain_ Trade Transaction. Details</b>
1 .. 1	<b>ASBIE CIOH_ Supply Chain_ Trade Transaction. Applicable. CIOH_ Supply Chain_ Trade Agreement</b> <b>Definition:</b> The trade agreement applicable to this CIOH supply chain trade transaction.
1 .. 1	<b>ASBIE CIOH_ Supply Chain_ Trade Transaction. Applicable. CIOH_ Supply Chain_ Trade Delivery</b> <b>Definition:</b> The trade delivery applicable to this CIOH supply chain trade transaction.
1 .. 1	<b>ASBIE CIOH_ Supply Chain_ Trade Transaction. Applicable. CIOH_ Supply Chain_ Trade Settlement</b> <b>Definition:</b> The trade settlement applicable to this CIOH supply chain trade transaction.
0 .. 1	<b>BBIE CIOH_ Supply Chain_ Trade Settlement. Tax_ Currency. Code</b> <b>Definition:</b> The code specifying the tax currency for this CIOH supply chain trade settlement.
0 .. 1	<b>BBIE CIOH_ Supply Chain_ Trade Settlement. Order_ Currency. Code</b> <b>Definition:</b> The code specifying the order currency for this CIOH supply chain trade settlement.
0 .. 1	<b>BBIE CIOH_ Supply Chain_ Trade Settlement. Invoice_ Currency. Code</b> <b>Definition:</b> The code specifying the invoice currency for this CIOH supply chain trade settlement.
0 .. 1	<b>BBIE CIOH_ Supply Chain_ Trade Settlement. Price_ Currency. Code</b> <b>Definition:</b> The code specifying the price currency for this CIOH supply chain trade settlement.
0 .. unbounded	<b>BBIE CIOH_ Supply Chain_ Trade Settlement. Due Payable. Amount</b> <b>Definition:</b> A monetary value that is an amount due and payable for this CIOH supply chain trade settlement, such as the amount due to the creditor.
0 .. 1	<b>ASBIE CIOH_ Supply Chain_ Trade Settlement. Invoicee. CI_ Trade_ Party</b> <b>Definition:</b> The party to whom an invoice is issued for this CIOH supply chain trade settlement.
0 .. 1	<b>ASBIE CIOH_ Supply Chain_ Trade Settlement. Payer. CI_ Trade_ Party</b> <b>Definition:</b> The payer party for this CIOH supply chain trade settlement.
0 .. 1	<b>ASBIE CIOH_ Supply Chain_ Trade Settlement. Tax_ Applicable. CI_ Trade_ Currency Exchange</b> <b>Definition:</b> The currency exchange applicable to a tax in this CIOH supply chain trade settlement.
0 .. 1	<b>ASBIE CIOH_ Supply Chain_ Trade Settlement. Order_ Applicable. CI_ Trade_ Currency Exchange</b> <b>Definition:</b> The currency exchange applicable to the order currency in this CIOH supply chain trade settlement.
0 .. 1	<b>ASBIE CIOH_ Supply Chain_ Trade Settlement. Invoice_ Applicable. CI_ Trade_ Currency Exchange</b> <b>Definition:</b> The currency exchange applicable to the invoice in this CIOH supply chain trade settlement.
0 .. 1	<b>ASBIE CIOH_ Supply Chain_ Trade Settlement. Price_ Applicable. CI_ Trade_ Currency Exchange</b> <b>Definition:</b> The currency exchange applicable to the price in this CIOH supply chain trade settlement.
0 .. 1	<b>ASBIE CIOH_ Supply Chain_ Trade Settlement. Specified. CI_ Trade Settlement_ Payment Means</b> <b>Definition:</b> The payment means specified for this CIOH supply chain trade settlement.
0 .. unbounded	<b>ASBIE CIOH_ Supply Chain_ Trade Settlement. Applicable. CI_ Trade_ Tax</b> <b>Definition:</b> A tax applicable to this CIOH supply chain trade settlement.
0 .. unbounded	<b>ASBIE CIOH_ Supply Chain_ Trade Settlement. Specified. CI_ Trade_ Allowance Charge</b> <b>Definition:</b> An allowance or charge specified for this CIOH supply chain trade settlement.
0 .. 1	<b>ASBIE CIOH_ Supply Chain_ Trade Settlement. Specified. CI_ Trade_ Payment Terms</b> <b>Definition:</b> The payment terms specified for this CIOH supply chain trade settlement.
0 .. 1	<b>ASBIE CIOH_ Supply Chain_ Trade Settlement. Specified. CIOH_ Trade Settlement_ Monetary Summation</b> <b>Definition:</b> The monetary summation totals specified for this CIOH supply chain trade settlement.
0 .. unbounded	<b>ASBIE CIOH_ Supply Chain_ Trade Settlement. Payable_ Specified. CI_ Trade_ Accounting Account</b> <b>Definition:</b> A payable accounting account specified for this CIOH supply chain trade settlement.
0 .. unbounded	<b>ASBIE CIOH_ Supply Chain_ Trade Settlement. Purchase_ Specified. CI_ Trade_ Accounting Account</b> <b>Definition:</b> A purchase accounting account specified for this CIOH supply chain trade settlement.

0 .. unbounded

ASBIE

**CIOH\_Supply Chain\_Trade Transaction. Included. CIOL\_Supply Chain\_Trade Line Item**

**Definition:**

A Cross Industry Ordering Line (CIOL) supply chain trade line item included in this CIOH supply chain trade transaction.

Occurrence	Element/Attribute
	<b>ABIE CIOH_ Supply Chain_ Trade Agreement. Details</b>
0 .. 1	<b>BBIE</b> <b>Definition:</b> CIOH_ Supply Chain_ Trade Agreement. Buyer_ Reference. Text The buyer reference, expressed as text, for this CIOH supply chain trade agreement.
0 .. 1	<b>ASBIE</b> <b>Definition:</b> <b>CIOH_ Supply Chain_ Trade Agreement. Seller. CI_ Trade_ Party</b> The party that is the seller for this CIOH supply chain trade agreement.
0 .. 1	<b>ASBIE</b> <b>Definition:</b> <b>CIOH_ Supply Chain_ Trade Agreement. Buyer. CI_ Trade_ Party</b> The party that is the buyer for this CIOH supply chain trade agreement.
0 .. 1	<b>ASBIE</b> <b>Definition:</b> <b>CIOH_ Supply Chain_ Trade Agreement. Buyer_ Assigned Accountant. CI_ Trade_ Party</b> The party assigned as an accountant by the buyer for this CIOH supply chain trade agreement.
0 .. 1	<b>ASBIE</b> <b>Definition:</b> <b>CIOH_ Supply Chain_ Trade Agreement. Seller Order_ Referenced. CI_ Referenced_ Document</b> The seller order document referenced in this CIOH supply chain trade agreement.
0 .. 1	<b>ASBIE</b> <b>Definition:</b> <b>CIOH_ Supply Chain_ Trade Agreement. Buyer Order_ Referenced. CI_ Referenced_ Document</b> The buyer order document referenced in this CIOH supply chain trade agreement.
0 .. 1	<b>ASBIE</b> <b>Definition:</b> <b>CIOH_ Supply Chain_ Trade Agreement. Marketplace Order_ Referenced. CI_ Referenced_ Document</b> The marketplace order document referenced in this CIOH supply chain trade agreement.
0 .. 1	<b>ASBIE</b> <b>Definition:</b> <b>CIOH_ Supply Chain_ Trade Agreement. Quotation_ Referenced. CI_ Referenced_ Document</b> The quotation document referenced in this CIOH supply chain trade agreement.
0 .. unbounded	<b>ASBIE</b> <b>Definition:</b> <b>CIOH_ Supply Chain_ Trade Agreement. Contract_ Referenced. CI_ Referenced_ Document</b> A contract document referenced in this CIOH supply chain trade agreement.
0 .. 1	<b>ASBIE</b> <b>Definition:</b> <b>CIOH_ Supply Chain_ Trade Agreement. Requisition_ Referenced. CI_ Referenced_ Document</b> The requisition document referenced in this CIOH supply chain trade agreement.
0 .. 1	<b>ASBIE</b> <b>Definition:</b> <b>CIOH_ Supply Chain_ Trade Agreement. Price List_ Referenced. CI_ Referenced_ Document</b> The price list document referenced in this CIOH supply chain trade agreement.
0 .. 1	<b>ASBIE</b> <b>Definition:</b> <b>CIOH_ Supply Chain_ Trade Agreement. Request For Quotation_ Referenced. CI_ Referenced_ Document</b> The request for quotation document referenced in this CIOH supply chain trade agreement.
0 .. 1	<b>ASBIE</b> <b>Definition:</b> <b>CIOH_ Supply Chain_ Trade Agreement. Sales Report_ Referenced. CI_ Referenced_ Document</b> The sales report document referenced in this CIOH supply chain trade agreement.
0 .. 1	<b>ASBIE</b> <b>Definition:</b> <b>CIOH_ Supply Chain_ Trade Agreement. Blanket Order_ Referenced. CI_ Referenced_ Document</b> The blanket order document referenced in this CIOH supply chain trade agreement.
0 .. 1	<b>ASBIE</b> <b>Definition:</b> <b>CIOH_ Supply Chain_ Trade Agreement. Previous Order_ Referenced. CI_ Referenced_ Document</b> The previous order document referenced in this CIOH supply chain trade agreement.
0 .. 1	<b>ASBIE</b> <b>Definition:</b> <b>CIOH_ Supply Chain_ Trade Agreement. Previous Order Change_ Referenced. CI_ Referenced_ Document</b> The previous order change document referenced in this CIOH supply chain trade agreement.
0 .. 1	<b>ASBIE</b> <b>Definition:</b> <b>CIOH_ Supply Chain_ Trade Agreement. Previous Order Response_ Referenced. CI_ Referenced_ Document</b> The previous order response document referenced in this CIOH supply chain trade agreement.
0 .. 1	<b>ASBIE</b> <b>Definition:</b> <b>CIOH_ Supply Chain_ Trade Agreement. Original Order_ Referenced. CI_ Referenced_ Document</b> The original order document referenced in this CIOH supply chain trade agreement.
0 .. 1	<b>ASBIE</b> <b>Definition:</b> <b>CIOH_ Supply Chain_ Trade Agreement. Engineering Change_ Referenced. CI_ Referenced_ Document</b> The engineering change document referenced in this CIOH supply chain trade agreement.

0 .. 1

**ASBIE**      **CIOH\_Supply Chain\_Trade Agreement. Letter Of Credit\_ Referenced. CI\_Referenced\_ Document**  
**Definition:**      The letter of credit document referenced in this CIOH supply chain trade agreement.

Occurrence	Element/Attribute
0 .. 1	<p>—ASBIE <b>CIOH_Supply Chain_Trade Agreement. Import Licence_ Referenced. CI_Referenced_ Document</b></p> <p><b>Definition:</b> The import licence document referenced in this CIOH supply chain trade agreement.</p>
0 .. 1	<p>—ASBIE <b>CIOH_Supply Chain_Trade Agreement. Export Licence_ Referenced. CI_Referenced_ Document</b></p> <p><b>Definition:</b> The export licence document referenced in this CIOH supply chain trade agreement.</p>
0 .. unbounded	<p>—ASBIE <b>CIOH_Supply Chain_Trade Agreement. Additional_ Referenced. CI_Referenced_ Document</b></p> <p><b>Definition:</b> An additional document referenced in this CIOH supply chain trade agreement.</p>



Occurrence	Element/Attribute
	<b>ABIE CIOH_ Supply Chain_ Trade Delivery. Details</b>
0 .. 1	<b>ASBIE CIOH_ Supply Chain_ Trade Delivery. Ship To. CI_ Trade_ Party</b> <b>Definition:</b> The ship to party for this CIOH supply chain trade delivery.
0 .. 1	<b>ASBIE CIOH_ Supply Chain_ Trade Delivery. Ship From. CI_ Trade_ Party</b> <b>Definition:</b> The ship from party for this CIOH supply chain trade delivery.
0 .. 1	<b>ASBIE CIOH_ Supply Chain_ Trade Delivery. Delivery. CI_ Delivery_ Instructions</b> <b>Definition:</b> The delivery instructions for this CIOH supply chain trade delivery.
0 .. 1	<b>ASBIE CIOH_ Supply Chain_ Trade Delivery. Planned_ Despatch. CI_ Supply Chain_ Event</b> <b>Definition:</b> The despatch event planned for this CIOH supply chain trade delivery.
0 .. 1	<b>ASBIE CIOH_ Supply Chain_ Trade Delivery. Planned_ Release. CI_ Supply Chain_ Event</b> <b>Definition:</b> The release event planned for this CIOH supply chain trade delivery.
0 .. 1	<b>ASBIE CIOH_ Supply Chain_ Trade Delivery. Planned_ Delivery. CI_ Supply Chain_ Event</b> <b>Definition:</b> The delivery event planned for this CIOH supply chain trade delivery.
0 .. unbounded	<b>ASBIE CIOH_ Supply Chain_ Trade Delivery. Planned. CI_ Supply Chain_ Consignment</b> <b>Definition:</b> A consignment planned for this CIOH supply chain trade delivery.

Occurrence	Element/Attribute
	<b>ABIE CIOH_ Supply Chain_ Trade Settlement. Details</b>
0 .. 1	—BBIE Definition: CIOH_ Supply Chain_ Trade Settlement. Tax_ Currency. Code The code specifying the tax currency for this CIOH supply chain trade settlement.
0 .. 1	—BBIE Definition: CIOH_ Supply Chain_ Trade Settlement. Order_ Currency. Code The code specifying the order currency for this CIOH supply chain trade settlement.
0 .. 1	—BBIE Definition: CIOH_ Supply Chain_ Trade Settlement. Invoice_ Currency. Code The code specifying the invoice currency for this CIOH supply chain trade settlement.
0 .. 1	—BBIE Definition: CIOH_ Supply Chain_ Trade Settlement. Price_ Currency. Code The code specifying the price currency for this CIOH supply chain trade settlement.
0 .. unbounded	—BBIE Definition: CIOH_ Supply Chain_ Trade Settlement. Due Payable. Amount A monetary value that is an amount due and payable for this CIOH supply chain trade settlement, such as the amount due to the creditor.
0 .. 1	—ASBIE <b>CIOH_ Supply Chain_ Trade Settlement. Invoicee. CI_ Trade_ Party</b> Definition: The party to whom an invoice is issued for this CIOH supply chain trade settlement.
0 .. 1	—ASBIE <b>CIOH_ Supply Chain_ Trade Settlement. Payer. CI_ Trade_ Party</b> Definition: The payer party for this CIOH supply chain trade settlement.
0 .. 1	—ASBIE <b>CIOH_ Supply Chain_ Trade Settlement. Tax_ Applicable. CI_ Trade_ Currency Exchange</b> Definition: The currency exchange applicable to a tax in this CIOH supply chain trade settlement.
0 .. 1	—ASBIE <b>CIOH_ Supply Chain_ Trade Settlement. Order_ Applicable. CI_ Trade_ Currency Exchange</b> Definition: The currency exchange applicable to the order currency in this CIOH supply chain trade settlement.
0 .. 1	—ASBIE <b>CIOH_ Supply Chain_ Trade Settlement. Invoice_ Applicable. CI_ Trade_ Currency Exchange</b> Definition: The currency exchange applicable to the invoice in this CIOH supply chain trade settlement.
0 .. 1	—ASBIE <b>CIOH_ Supply Chain_ Trade Settlement. Price_ Applicable. CI_ Trade_ Currency Exchange</b> Definition: The currency exchange applicable to the price in this CIOH supply chain trade settlement.
0 .. 1	—ASBIE <b>CIOH_ Supply Chain_ Trade Settlement. Specified. CI_ Trade Settlement_ Payment Means</b> Definition: The payment means specified for this CIOH supply chain trade settlement.
0 .. unbounded	—ASBIE <b>CIOH_ Supply Chain_ Trade Settlement. Applicable. CI_ Trade_ Tax</b> Definition: A tax applicable to this CIOH supply chain trade settlement.
0 .. unbounded	—ASBIE <b>CIOH_ Supply Chain_ Trade Settlement. Specified. CI_ Trade_ Allowance Charge</b> Definition: An allowance or charge specified for this CIOH supply chain trade settlement.
0 .. 1	—ASBIE <b>CIOH_ Supply Chain_ Trade Settlement. Specified. CI_ Trade_ Payment Terms</b> Definition: The payment terms specified for this CIOH supply chain trade settlement.
0 .. 1	—ASBIE <b>CIOH_ Supply Chain_ Trade Settlement. Specified. CIOH_ Trade Settlement_ Monetary Summation</b> Definition: The monetary summation totals specified for this CIOH supply chain trade settlement.
0 .. unbounded	—ASBIE <b>CIOH_ Supply Chain_ Trade Settlement. Payable_ Specified. CI_ Trade_ Accounting Account</b> Definition: A payable accounting account specified for this CIOH supply chain trade settlement.
0 .. unbounded	—ASBIE <b>CIOH_ Supply Chain_ Trade Settlement. Purchase_ Specified. CI_ Trade_ Accounting Account</b> Definition: A purchase accounting account specified for this CIOH supply chain trade settlement.

Occurrence	Element/Attribute
	<p><b>ABIE</b></p> <p><b>CIOH_Trade Settlement_Monetary Summation. Details</b></p>
0 .. unbounded	<p>—BBIE CIOH_Trade Settlement_Monetary Summation. Line Total. Amount Definition: A monetary value of the line amount total being reported in this CIOH trade settlement monetary summation.</p>
0 .. unbounded	<p>—BBIE CIOH_Trade Settlement_Monetary Summation. Charge Total. Amount Definition: A monetary value of the total of all charge amounts being reported in this CIOH trade settlement monetary summation.</p>
0 .. unbounded	<p>—BBIE CIOH_Trade Settlement_Monetary Summation. Allowance Total. Amount Definition: A monetary value of the total of all allowance amounts being reported in this CIOH trade settlement monetary summation.</p>
0 .. unbounded	<p>—BBIE CIOH_Trade Settlement_Monetary Summation. Tax Basis Total. Amount Definition: A monetary value of the total of all tax basis amounts being reported in this CIOH trade settlement monetary summation.</p>
0 .. unbounded	<p>—BBIE CIOH_Trade Settlement_Monetary Summation. Tax Total. Amount Definition: A monetary value of the total of all tax amounts being reported in this CIOH trade settlement monetary summation.</p>
0 .. unbounded	<p>—BBIE CIOH_Trade Settlement_Monetary Summation. Rounding. Amount Definition: A monetary value of a rounding amount being applied in this CIOH trade settlement monetary summation.</p>
0 .. unbounded	<p>—BBIE CIOH_Trade Settlement_Monetary Summation. Grand Total. Amount Definition: A monetary value of the grand total of this CIOH trade settlement monetary summation, to include addition and subtraction of individual summation amounts.</p>

Occurrence	Element/Attribute
	<b>ABIE</b> <b>CIOL_ Supply Chain_ Trade Line Item. Details</b>
1 .. 1	<b>ASBIE</b> <b>CIOL_ Supply Chain_ Trade Line Item. Associated. CIOL_ Document Line_ Document</b> <b>Definition:</b> The document line associated with this CIOL supply chain trade line item.
0 .. 1	<b>ASBIE</b> <b>CIOL_ Supply Chain_ Trade Line Item. Specified. CIOL_ Supply Chain_ Trade Agreement</b> <b>Definition:</b> The trade agreement specified for this CIOL supply chain trade line item.
0 .. 1	<b>ASBIE</b> <b>CIOL_ Supply Chain_ Trade Line Item. Specified. CIOL_ Supply Chain_ Trade Delivery</b> <b>Definition:</b> The trade delivery specified for this CIOL supply chain trade line item.
0 .. 1	<b>ASBIE</b> <b>CIOL_ Supply Chain_ Trade Line Item. Specified. CIOL_ Supply Chain_ Trade Settlement</b> <b>Definition:</b> The trade settlement specified for this CIOL supply chain trade line item.
0 .. 1	<b>ASBIE</b> <b>CIOL_ Supply Chain_ Trade Line Item. Specified. CI_ Trade_ Product</b> <b>Definition:</b> The product specified for this CIOL supply chain trade line item.
0 .. 1	<b>ASBIE</b> <b>CIOL_ Supply Chain_ Trade Line Item. Substituted. CI_ Referenced_ Product</b> <b>Definition:</b> The Cross Industry (CI) referenced product substituted for this CIOL supply chain trade line item.

Occurrence	Element/Attribute
	<b>ABIE</b> <b>CIOL_ Document Line_ Document. Details</b>
1 .. 1	<b>BBIE</b> CIOL_ Document Line_ Document. Line. Identifier Definition: The identifier of this CIOL document line.
0 .. 1	<b>BBIE</b> CIOL_ Document Line_ Document. UUID_ Line. Identifier Definition: The universally unique identifier (UUID) of this CIOL document line.
0 .. 1	<b>BBIE</b> CIOL_ Document Line_ Document. Line Status. Code Definition: The code specifying the status of this CIOL document line.
0 .. 1	<b>BBIE</b> CIOL_ Document Line_ Document. Line Status Reason. Code Definition: The code specifying the line status reason for this CIOL document line.
0 .. unbounded	<b>ASBIE</b> <b>CIOL_ Document Line_ Document. Included. CI_ Note</b> Definition: A note included in this CIOL document line.

Occurrence	Element/Attribute
	<b>ABIE</b> <b>CIOL_ Supply Chain_ Trade Agreement. Details</b>
0 .. 1	<b>BBIE</b> <b>CIOL_ Supply Chain_ Trade Agreement. Buyer_ Reference. Text</b> <b>Definition:</b> The buyer reference, expressed as text, for this CIOL supply chain trade agreement.
0 .. 1	<b>ASBIE</b> <b>CIOL_ Supply Chain_ Trade Agreement. Seller. CI_ Trade_ Party</b> <b>Definition:</b> The party that is the seller in this CIOL supply chain trade agreement.
0 .. 1	<b>ASBIE</b> <b>CIOL_ Supply Chain_ Trade Agreement. Buyer_ Requisitioner. CI_ Trade_ Party</b> <b>Definition:</b> The party that is the buyer requisitioner in this CIOL supply chain trade agreement.
0 .. 1	<b>ASBIE</b> <b>CIOL_ Supply Chain_ Trade Agreement. Seller Order_ Referenced. CI_ Referenced_ Document</b> <b>Definition:</b> The seller order document referenced by this CIOL supply chain trade agreement.
0 .. 1	<b>ASBIE</b> <b>CIOL_ Supply Chain_ Trade Agreement. Buyer Order_ Referenced. CI_ Referenced_ Document</b> <b>Definition:</b> The buyer order document referenced by this CIOL supply chain trade agreement.
0 .. 1	<b>ASBIE</b> <b>CIOL_ Supply Chain_ Trade Agreement. Marketplace Order_ Referenced. CI_ Referenced_ Document</b> <b>Definition:</b> The marketplace order document referenced in this CIOL supply chain trade agreement.
0 .. 1	<b>ASBIE</b> <b>CIOL_ Supply Chain_ Trade Agreement. Quotation_ Referenced. CI_ Referenced_ Document</b> <b>Definition:</b> The quotation document referenced by this CIOL supply chain trade agreement.
0 .. 1	<b>ASBIE</b> <b>CIOL_ Supply Chain_ Trade Agreement. Contract_ Referenced. CI_ Referenced_ Document</b> <b>Definition:</b> The contract document referenced by this CIOL supply chain trade agreement.
0 .. 1	<b>ASBIE</b> <b>CIOL_ Supply Chain_ Trade Agreement. Requisition_ Referenced. CI_ Referenced_ Document</b> <b>Definition:</b> The requisition document referenced by this CIOL supply chain trade agreement.
0 .. 1	<b>ASBIE</b> <b>CIOL_ Supply Chain_ Trade Agreement. Request For Quotation_ Referenced. CI_ Referenced_ Document</b> <b>Definition:</b> The request for quotation document referenced by this CIOL supply chain trade agreement.
0 .. 1	<b>ASBIE</b> <b>CIOL_ Supply Chain_ Trade Agreement. Sales Report_ Referenced. CI_ Referenced_ Document</b> <b>Definition:</b> The sales report document referenced by this CIOL supply chain trade agreement.
0 .. 1	<b>ASBIE</b> <b>CIOL_ Supply Chain_ Trade Agreement. Blanket Order_ Referenced. CI_ Referenced_ Document</b> <b>Definition:</b> The blanket order document referenced by this CIOL supply chain trade agreement.
0 .. 1	<b>ASBIE</b> <b>CIOL_ Supply Chain_ Trade Agreement. Previous Order_ Referenced. CI_ Referenced_ Document</b> <b>Definition:</b> The previous order document referenced by this CIOL supply chain trade agreement.
0 .. 1	<b>ASBIE</b> <b>CIOL_ Supply Chain_ Trade Agreement. Original Order_ Referenced. CI_ Referenced_ Document</b> <b>Definition:</b> The original order document referenced by this CIOL supply chain trade agreement.
0 .. 1	<b>ASBIE</b> <b>CIOL_ Supply Chain_ Trade Agreement. Engineering Change_ Referenced. CI_ Referenced_ Document</b> <b>Definition:</b> The engineering change document referenced by this CIOL supply chain trade agreement.
0 .. 1	<b>ASBIE</b> <b>CIOL_ Supply Chain_ Trade Agreement. Letter Of Credit_ Referenced. CI_ Referenced_ Document</b> <b>Definition:</b> The letter of credit document referenced by this CIOL supply chain trade agreement.
0 .. 1	<b>ASBIE</b> <b>CIOL_ Supply Chain_ Trade Agreement. Import Licence_ Referenced. CI_ Referenced_ Document</b> <b>Definition:</b> The import licence document referenced by this CIOL supply chain trade agreement.
0 .. 1	<b>ASBIE</b> <b>CIOL_ Supply Chain_ Trade Agreement. Export Licence_ Referenced. CI_ Referenced_ Document</b> <b>Definition:</b> The export licence document referenced by this CIOL supply chain trade agreement.
0 .. 1	<b>ASBIE</b> <b>CIOL_ Supply Chain_ Trade Agreement. Catalogue_ Referenced. CI_ Referenced_ Document</b> <b>Definition:</b> The catalogue document referenced by this CIOL supply chain trade agreement.

0 .. unbounded	ASBIE	<b>CIOL_ Supply Chain_ Trade Agreement. Additional_ Referenced. CI_ Referenced_ Document</b>
	Definition:	An additional document referenced by this CIOL supply chain trade agreement.
0 .. 1	ASBIE	<b>CIOL_ Supply Chain_ Trade Agreement. Gross Price_ Product. CI_ Trade_ Price</b>
	Definition:	The gross price for the product in this CIOL supply chain trade agreement.
0 .. 1	ASBIE	<b>CIOL_ Supply Chain_ Trade Agreement. Net Price_ Product. CI_ Trade_ Price</b>
	Definition:	The net price for the product in this CIOL supply chain trade agreement.

Occurrence	Element/Attribute
	<b>ABIE</b> <b>CIOL_ Supply Chain_ Trade Delivery. Details</b>
0 .. 1	—BBIE Definition: CIOL_ Supply Chain_ Trade Delivery. Requested. Quantity The requested quantity for this CIOL supply chain trade delivery.
0 .. 1	—BBIE Definition: CIOL_ Supply Chain_ Trade Delivery. Agreed. Quantity The agreed quantity for this CIOL supply chain trade delivery.
0 .. 1	—BBIE Definition: CIOL_ Supply Chain_ Trade Delivery. Partial Delivery Allowed. Indicator The indication of whether or not partial delivery is allowed for this CIOL supply chain trade delivery.
0 .. 1	—ASBIE <b>CIOL_ Supply Chain_ Trade Delivery. Ship To. CI_ Trade_ Party</b> Definition: The ship to party for this CIOL supply chain trade delivery.
0 .. 1	—ASBIE <b>CIOL_ Supply Chain_ Trade Delivery. Ship From. CI_ Trade_ Party</b> Definition: The ship from party for this CIOL supply chain trade delivery.
0 .. 1	—ASBIE <b>CIOL_ Supply Chain_ Trade Delivery. Delivery. CI_ Delivery_ Instructions</b> Definition: The delivery instructions for this CIOL supply chain trade delivery.
0 .. unbounded	—ASBIE <b>CIOL_ Supply Chain_ Trade Delivery. Additional_ Referenced. CI_ Referenced_ Document</b> Definition: An additional referenced document, such as a delivery document, for this CIOL supply chain trade delivery.
0 .. 1	—ASBIE <b>CIOL_ Supply Chain_ Trade Delivery. Planned. CI_ Supply Chain_ Consignment</b> Definition: The consignment planned for this CIOL supply chain trade delivery.
0 .. 1	—ASBIE <b>CIOL_ Supply Chain_ Trade Delivery. Requested_ Delivery. CI_ Supply Chain_ Event</b> Definition: The requested delivery event for this CIOL supply chain trade delivery.
0 .. 1	—ASBIE <b>CIOL_ Supply Chain_ Trade Delivery. Confirmed_ Delivery. CI_ Supply Chain_ Event</b> Definition: The confirmed delivery event for this CIOL supply chain trade delivery.
0 .. 1	—ASBIE <b>CIOL_ Supply Chain_ Trade Delivery. Projected. CI_ Supply Chain_ Supply Plan</b> Definition: The supply plan projected for this CIOL supply chain trade delivery.



Occurrence	Element/Attribute
	<b>ABIE</b> <b>CIOL_ Supply Chain_ Trade Settlement. Details</b>
0 .. 1	<b>ASBIE</b> <b>CIOL_ Supply Chain_ Trade Settlement. Invoicee. CI_ Trade_ Party</b> <b>Definition:</b> The party to whom an invoice should be issued for this CIOL supply chain trade settlement.
0 .. 1	<b>ASBIE</b> <b>CIOL_ Supply Chain_ Trade Settlement. Payer. CI_ Trade_ Party</b> <b>Definition:</b> The payer party for this CIOL supply chain trade settlement.
0 .. unbounded	<b>ASBIE</b> <b>CIOL_ Supply Chain_ Trade Settlement. Applicable. CI_ Trade_ Tax</b> <b>Definition:</b> A tax applicable to this CIOL supply chain trade settlement.
0 .. unbounded	<b>ASBIE</b> <b>CIOL_ Supply Chain_ Trade Settlement. Specified. CI_ Trade_ Allowance Charge</b> <b>Definition:</b> An allowance or charge specified for this CIOL supply chain trade settlement.
0 .. 1	<b>ASBIE</b> <b>CIOL_ Supply Chain_ Trade Settlement. Specified. CIOL_ Trade Settlement_ Monetary Summation</b> <b>Definition:</b> The monetary summation specified for this CIOL supply chain trade settlement.

Occurrence	Element/Attribute
	<b>ABIE</b>
	<b>CIOL_Trade Settlement_Monetary Summation. Details</b>
0 .. unbounded	BBIE Definition: CIOL_Trade Settlement_Monetary Summation. Line Total. Amount A monetary value of the line amount total being reported in this CIOL trade settlement monetary summation.
0 .. unbounded	BBIE Definition: CIOL_Trade Settlement_Monetary Summation. Charge Total. Amount A monetary value of the total of all charge amounts being reported in this CIOL trade settlement monetary summation.
0 .. unbounded	BBIE Definition: CIOL_Trade Settlement_Monetary Summation. Allowance Total. Amount A monetary value of the total of all allowance amounts being reported in this CIOL trade settlement monetary summation.

## 8. Core components UN/CEFACT Registry version used

This RSM is based on the UN/CEFACT Core Component Library (CCL), version 10A.



## 9. Draft Core Component reference

All the Aggregate Business Information Entities (ABIES) required to meet the business requirements of Cross Industry Order are defined in section 7.2 of this RSM and correspond to the same entries in CCL09B

## 10. Additional documentation

TBG1 RSM Report – Cross Industry Supply Chain Process - Common Requirements – 10A, UN/CEFACT TBG1 - 2010

## 11. Additional information

All ABIEs from CCL	 ABIEs.xmi
CIO Class diagrams	 CIO.xmi
Business Message Templates	 CCL10A TBG1 CIO MA Template.xls